

INDEX

INDEX.....	错误! 未定义书签。
1. PRODUCT INTRODUCTION.....	- 2 -
2. SPECIFICATIONS.....	错误! 未定义书签。
2.1、DISPLAY.....	- 3 -
2.2、FEATURES AND SPECIFICATIONS OF AXIS CONTROL.....	- 3 -
2.3、ENVIRONMENT TEMPERATURE.....	- 3 -
3. CONTROL PANEL	
3.1、CONTROL PANEL.....	- 4 -
3.2、SYSTEM INTRODUCTION.....	- 4 -
4. AUXILIARY FUNCTIONS.....	- 6 -
4.1 AUXILIARY FUNCTIONS INTERFACE.....	- 6 -
4.1.1 <i>Interface introduction</i>	- 6 -
4.2 CONFIGURATION INTERFACE.....	- 6 -
4.2.1 <i>Interface introduction</i>	- 7 -
4.2.2 <i>Configuration</i>	- 7 -
4.2.3 <i>Save Setting</i>	- 7 -
4.3 Chinese/English Language Selection.....	- 8 -
4.4 METRIC/IMPERIAL SYSTEM SWITCH.....	- 8 -
4.5 TEST INTERFACE.....	- 9 -
4.5.1 <i>Test Interface Introduction</i>	- 9 -
4.5.2 <i>Blade Clearance</i>	- 9 -
4.5.3 <i>Switch Test</i>	- 11 -
4.5.4 <i>Key test</i>	- 12 -
4.5.5 <i>Set position</i>	- 12 -
5. PROCESS INTERFACE.....	- 14 -
5.1 INTERFACE DISPLAY.....	- 14 -
5.2 TERMS.....	- 14 -
5.3 OPERATION.....	- 14 -
5.4 NOTES.....	- 15 -
5.5 SAMPLE.....	- 15 -
6. APPENDIX.....	- 16 -
6.1 ENCODER INTERFACE CONNECTION TABLE.....	- 16 -
6.2 J4、J3、J7INTERFACE INPUT/OUTPUT CHART.....	- 16 -
6.3 SYSTEM INTERFACE CHART.....	- 17 -
6.4 TROUBLE-SHOOTING.....	- 18 -

1. Product Introduction

The Wonder Shears Control System has combined all the cutting-edge technologies and is tailor-made for Chinese customers.

The product, built with solid alloy, is elegant, easy to operate, efficient and stable.

Features:

- 1、 64*128 LCD display;
- 2、 High-end blue monitor;
- 3、 High-definition Chinese display;
- 4、 English/Chinese dual language support;
- 5、 Digitalized display of X/Y axis;
- 6、 Accurate control;
- 7、 Self-diagnosis of exterior switch;
- 8、 Smart alarm system;
- 9、 Optional exterior switches;
- 10、 Standard RS232/485 interface ;
- 11、 One-way orientation.

2. Specifications

2.1、Display

64*128LCD display;

2 status indicator, one for operation and the other for stop.

2.2、Features and specifications of axis control

1、The system controls one axis (X、Y):

Axis X controls forward/backward movement of back gauge;

Axis Y only displays the rake angle.

2、Power Supply:

Input voltage: DC24V±2%

Maximum current: 5A

2.3、Environment temperature

Working environment temperature: 0 ~ 45°C

Storage environment temperature: 0 ~ 70°C

3. Control Panel

3.1、Control panel



3.2、System introduction

1、Display window:

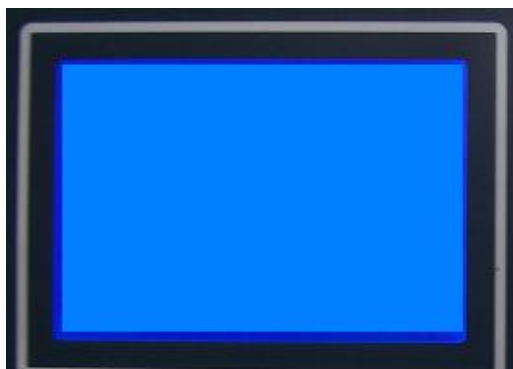

2、Key introduction:

1) Function keys:



-----clears the current and previous values;



-----confirm and save;



-----quit and back;



-----move cursor up;



-----move cursor down;



-----plus/slow backward;



-----minus/slow forward.

2) Status keys:



-----starts the system;



-----stops the system;

/enter auxiliary functions interface;

3) Digital input keys:

“0~9” -----10 digits;



----- the point key

3、Indicators:

System status indicators:



-----indicating “operating” ;



-----indicating “stop” .



4. Auxiliary Functions

4.1 Auxiliary functions interface

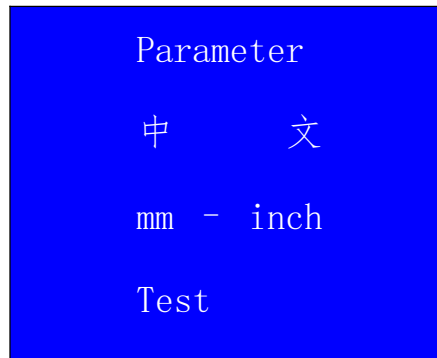
How to enter: hold the stop key  to enter the auxiliary functions interface, as shown below:



4.1.1 Interface introduction

Press  or  to switch between lines and choose the function you wish to set:

The words “Auxiliary functions” is shown on the left of the LCD screen;

Line 1: configuration, press  to enter;

Line 2: displaying Chinese or English, press  to switch between Chinese and English;

Line 3: press  switch between metric and imperial units;

Line 4: press  to enter testing interface;

4.2 Configuration

When the cursor stays on the first line of “auxiliary functions”, press  to start configuration, as shown below:

FLimit:	0.00
BLimit:	0.00
Molecul:	1
Denomin:	1

4.2.1 Interface introduction



Line 1: front limit, the zero position;

Line 2: back limit, the backward movement limit of gauge motor;

Line 3: molecule, in direct proportion to line 4;



Line 4: denominator, in inverse proportion to line 3;

4.2.2 Configuration

Press  or  to switch between lines and choose the parameter you wish to change;

How to change: move the cursor to the target parameter, press  to clear the current value and input the new value with the digit keys (0~9);

4.2.3 Save setting

After configuration, press  to confirm and the system will notify: “save changes”, then press  and the system will require to enter the three-digit password (147) , finish saving and return to the configuration interface. Press  to ignore changes.

4.2.4 Molecule/denominator calculation

1). How to calculate:

$$\text{Molecule/denominator} = \text{screw lead} * 100 / \text{encoder line amount}$$

For example, the screw lead is 10mm, while the encoder has

400 lines

Molecule/denominator=10*100/400=5/2

The result is 5/2, 5 being the molecule and 2 the denominator.

Input 5 to “Molecul” and 2 to “Denomin”.

4.3 English/Chinese language selection

When the cursor is on the second line of “auxiliary functions”, press  to switch between English and Chinese, as shown below:

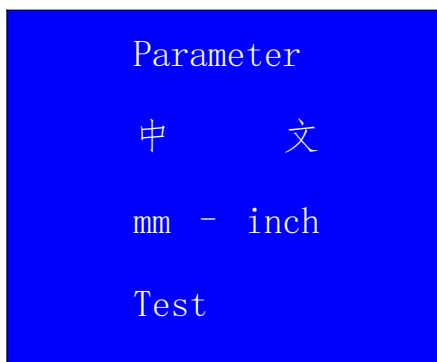

Move the cursor to the second line and press  to show Chinese, as shown below:



4.4 Metric/imperial system switch

When the cursor is on the third line, press  to switch between



metric units and imperial units.

Note: this function is only available in exported machines.

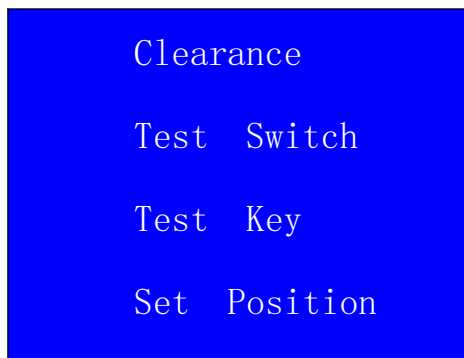
4.5 Test interface



4.5.1 Interface introduction

- 1、Line one: blade clearance;
- 2、Line two: press  to enter test switch interface;;
- 3、Line three: press  to enter test key interface;
- 4、Line four: press  to set position.

4.5.2 Blade clearance

1. When the cursor is on the first line, press  to enter the “blade clearance” interface. Input a three-digit password (258) as indicated and enter the interface as shown below:

ELines:	0
CleMin:	0.00
CleMax:	0.00
ECount:	0

2. Terms



Elines: encoder lines;





CleMin: minimum clearance;



CleMax: maximum clearance;

Ecount: the number of pulses received by the encoder during clearance adjustment. No setting required.



3. Operation

When the cursor points to “Elines”, press  to clear the value and input the new value with digit keys, press  to confirm and the cursor automatically jumps to “CleMin”.

Press  to clear the “CleMin” value and input the new value with digit keys; press  to confirm and the cursor automatically jumps to “CleMax” (meanwhile “ECount” clears automatically), press  to save setting. Press  again to confirm and system returns to main interface.



After saving “Elines” and “CleMin”, run the clearance adjustment motor (or adjust manually) to test the maximum clearance, then input the value to “CleMax”. Press  to save and press  to return to the main interface.

4. Notes:

1. Press  to quit the current interface;
2. The cursor can only be operated through the  key in “blade clearance” interface;
3. No setting required for “ECount”;
4. The “CleMax” value can be set along with “ELines” and “CleMin”, or set later after getting the accurate value.

4.5.3 Test switch

1. Operation:

Move the cursor to “test switch” through  or  , then press  to enter the “test switch” interface, as shown below:

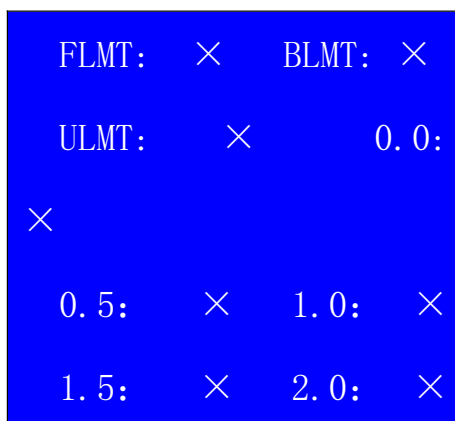

2. Terms

FLMT: the front limit of back gauge;

BLMT: the back limit of back gauge;

ULMT: the up limit of back gauge;

0.0: 0 degree rake angle;

0.5: 0.5 degrees rake angle;

1.0: 1.0 degrees rake angle;

1.5: 1.5 degrees rake angle;



2.0: 2.0 degrees rake angle.





3. Test and Diagnosis

Turn the limit switch or approach it with metal, “√” and “×” signals shall appear on the screen; if not, please refer to appendix “6.4 Trouble-shooting”.

4.5.4 Test key

1. Operation



Move the cursor to “test key” through  or , and press  to enter the “test key” interface. Each key corresponds to a value, as shown below:

Key	Value	Key	Value	Key	Value
0	00	7	07	OK	18
1	01	8	08		16
2	02	9	09	+	11
3	03		1D	—	12
4	04		1E		17
5	05		1F	ESC	19
6	06	•	15		

2. After testing, press  twice to quit “test key” interface.





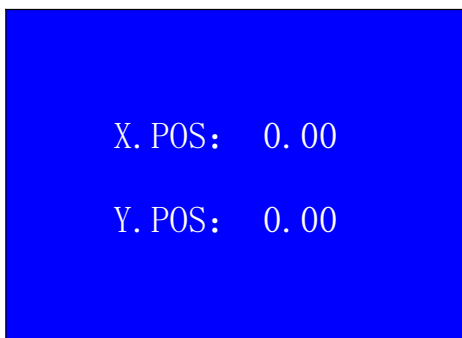

4.5.5 Set position

1. Operation

Move the cursor to “set position” through  or , press  to enter the “set position” interface. Enter a three-digit password (258) as required, and the following

screen appears:



Press  to delete the “X. POS” value and enter the new value with digit keys; press  or  to move the cursor to “Y. POS”, press  to delete the “X. POS” value and enter the new value with digit keys. Press  to save, press  again to confirm.

Press  to quit the current interface if finished saving or no saving is required.

2. Terms

XPOS: the current position of back gauge-current value;

YPOS: the current value of blade clearance, the same as “Cleara” in the processing interface.

3. Notes

1. The value of “Y. POS” can be acquired from the “Cleara” item of the processing interface and need not to be calculated.

2. Set the “blade clearance” parameter first and “current value” later.

5 Processing Interface

5.1 Interface Display

C. Pos:	0.00
Cleara:	0.00
Count:	+ 0
Angle:	0°

5.2 Terms

C.POS: the current position of back gauge;

Cleara: the current blade clearance;

Count: set the number of strokes;

Angle: the cutting angle.

5.3 Operation

1. Adjust blade clearance;

2. Adjust rake angle;

3. input “count” value;

4. Press  to clear C.POS value;

5. Input target position value with digit keys;

6. Press  to confirm input;

7. Press  and system starts automatic-positioning, and will stop after reaching the target position.



8. Press foot pedal to start shearing.

5.4 Notes

1. The screen only shows “Cleara” and “Angle” value;
2. The “Angle” value is only effective when the blade is at “ULimit”.

5.5 Sample

To cut a blank which is 100mm wide, 2.0 thick in 20 strokes, please follow the procedures below:

1. Adjust blade gap;
2. Adjust rake angle;
3. Input the number of strokes (20) in “counts” ;
4. Press  to clear the “C.POS” value;
5. Input the width value 100;
6. Press  to confirm;
7. Press  , the system starts automatic-positioning, and stops at the target position 100;
8. Press foot pedal to start shearing.

6 Appendix

6.1 Encoder Interface Connection Table

(J1) Interface	Axis X encoder interface	Color
1	A	Red
2	B	Green
3	Z	Yellow
4	0V	Black
5	+5V	White
6	/A	Pink
7	/B	Blue
8	/Z	Orange
9	Shield	Shield

Notes: 1. encoder output mode: long-line driver L (AM26LS31);
2. The color of lines may change.

6.2 J4、J3、J7 Interface input and output chart

1. J4 Input Signal Table

No.	Signal
1	0V
2	
3	Front limit
4	Back limit
5	Up limit
6	0.0
7	0.5
8	1.0
9	1.5
10	2.0

2. J3 Output signal table

No.	Signal
10	Backup
9	
8	
7	
6	
5	Forward
4	Backward
3	0V
2	
1	

3. J7 Input signal table

Interface no.	Signal
1	24V
2	0V
3	0V
4	24V

6.3 System Interface Chart

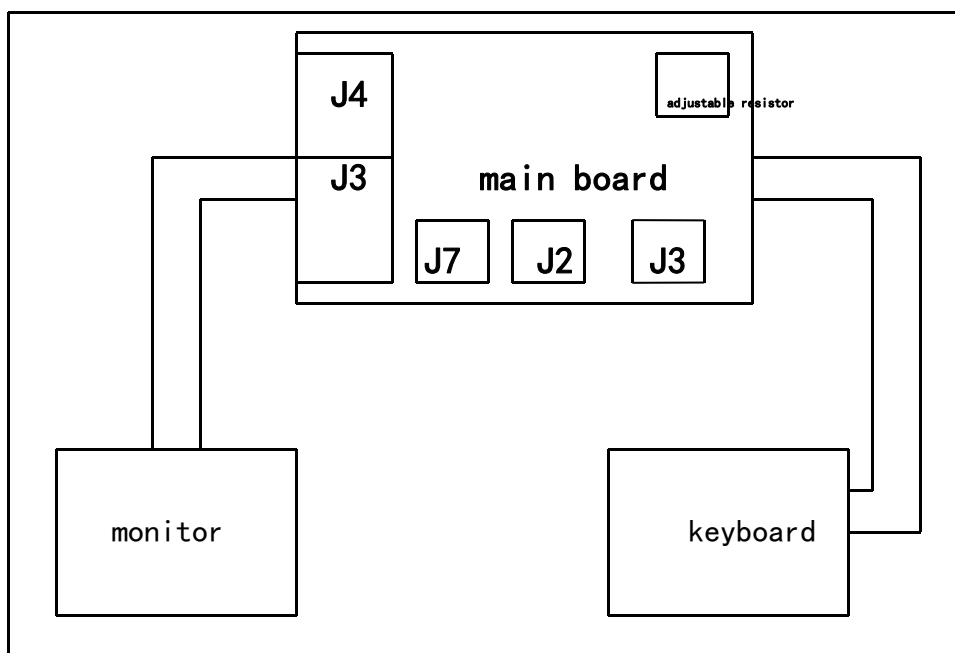

6.4 Troubleshooting

Back gauge at back limit	Check whether the limit switch is at the “on” (NO) position, or the back limit value is too small (current value >back limit value), or the limit switch is damaged.
Back gauge at front limit	Check whether the limit switch is at the “on” (NO) position, or the front limit value is too large (current value >front limit value), or the limit switch is damaged.
Back gauge at up limit	Check whether the limit switch is at the “on” (NO) position, or the blade is not at the up limit, or the limit switch is damaged.
Flickering screen	Check whether the line is loose, power supply is normal, or there’s any electric interference.
0.0: ×	The proximity switch has no signal or is damaged; poor connection or communication errors.
0,5: ×	The proximity switch has no signal or is damaged; poor connection or communication errors.
1.0: ×	The proximity switch has no signal or is damaged; poor connection or communication errors.
1.5: ×	The proximity switch has no signal or is damaged; poor connection or communication errors.

2.0: ×	The proximity switch has no signal or is damaged; poor connection or communication errors.
--------	--

Shall other problems occur, please contact the local dealer or Shenzhen Wonder Control Technology Co., Ltd.

Shenzhen Wonder Control Technology Co., Ltd.
Wuxi Wonder Control Technology Co., Ltd.
Service
Hotline: 86-0510-85898600/83729992